

Par 56 Lantern

Par 56 lanterns are supplied with integral wire mesh, cable grip gland, lamp retaining ring, colour frame retainers (gell clips) and spring loaded 4th gell foot. Standard finishes are semi matt black or silver - black interior, other finishes will be priced on application. RAL colour number is required for identification.

Par 56 Standard		Par 56 Shortnose		Par 56 Floorlite	
Colour	Product code	Colour	Product code	Colour	Product code
Black	A5600	Black	A5603	Black	A5606
Silver	A5601	Silver	A5604	Silver	A5607
Colour	A5602	Colour	A5605	Colour	A5608
Weight	1.52 kg	Weight	1.39 kg	Weight	1.66 kg

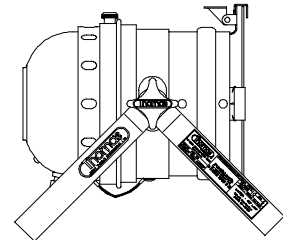
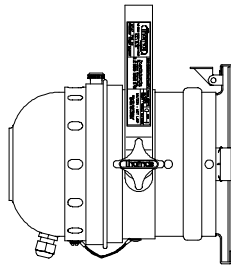
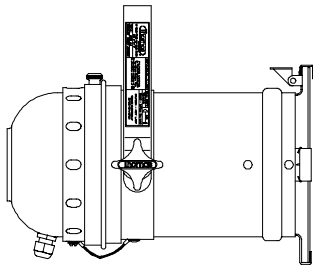

In addition to the types shown above we manufacture lanterns that conform with European regulations. These are listed below with specification details.

Type	Add suffix	Type of use and standard to which the product conforms.
Professional version	P	Permanent installations in Europe requiring conformity to EN60598-2-17, Health and safety recommendations and the Low Voltage Directive. CE marked.
"S" version	S	General use in Europe requiring conformity to the Low Voltage Directive when using CP type sealed beam lamps. CE marked.
"R" version	R	General use in Europe requiring conformity to the Low Voltage Directive when using Raylite reflector and lamp. CE marked.

Par 56 Lantern specification

Thick gauge spun aluminium construction, 12mm mesh, gell feet with retaining clips, spring loaded 4 th gell foot, lamp retaining ring, earth position, Operating instructions, identification label, spring loaded 4th gell foot and can to body safety earth bond and 16mm gland

Par 56 Lantern with "S" specification.

All above features plus Lamp adjuster and wiring set. **CE** marked.

Par 56 Lantern with "R" specification.

All above features plus Lamp adjuster, wiring set and 3mm mesh. **CE** marked.

Par 56 Lantern Professional specification.

All above features plus Lamp adjuster, wiring set, 3mm mesh, cap to body hinge, cap mesh, body mounted safety wire and cap release screw. **CE** marked.

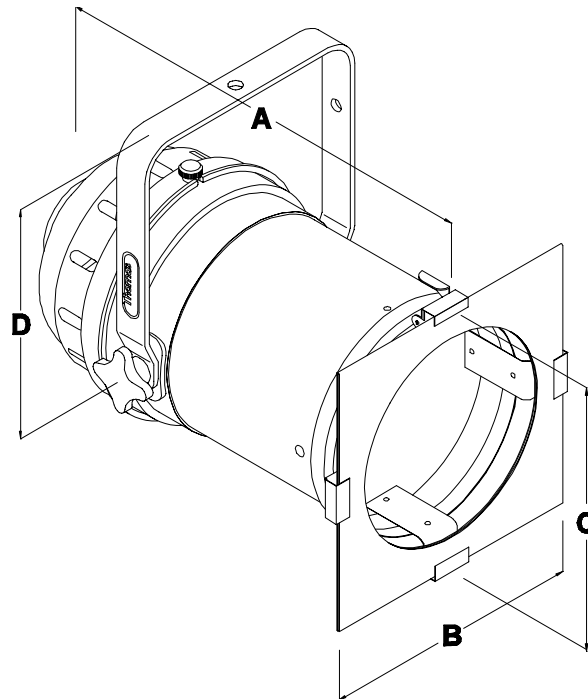

DIMENSIONS (MM)					
DESCRIPTION	A Standard	A Professional, "S" & "R" specification	B	C	D
PAR 56 Standard	355	379	240	223	186
PAR 56 Shortnose	260	284	240	223	186
PAR 56 Floorlite	260	284	240	223	212
PAR 56 Outdoor	308	-	265	228	238

ACCESSORIES FOR PAR 56 LANTERNS

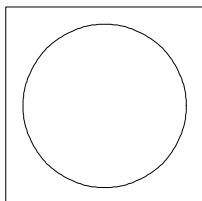

PRODUCT CODE	DESCRIPTION	SIZE mm	WT kgs
D5650	Square Colour Frame Black	229 x 229	0.106
D5651	Square Colour Frame Silver		
D5652	Square Colour Frame Colour		

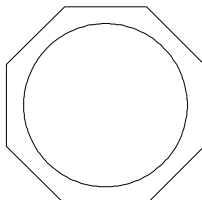

D5656	Octagonal Colour Frame Black	229 x 229	0.098
D5657	Octagonal Colour Frame Silver		
D5658	Octagonal Colour Frame Colour		

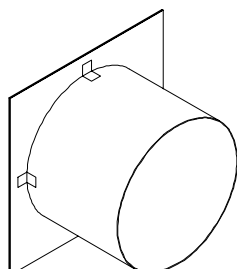

B5603	Spill Ring & Colour Frame	229 x 229 x 100	0.24
-------	---------------------------	--------------------	------

Par 56 Lantern

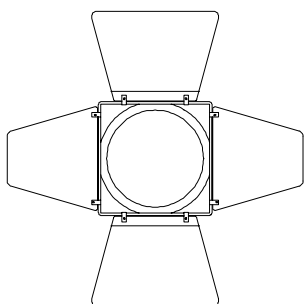

PRODUCT CODE	DESCRIPTION	WT kgs
D5660	4 Way Barn Door Black	0.838
D5661	4 Way Barn Door Silver	0.838

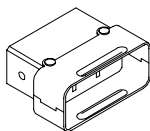

G0000	Re-wireable Ceramic	0.079
-------	---------------------	-------

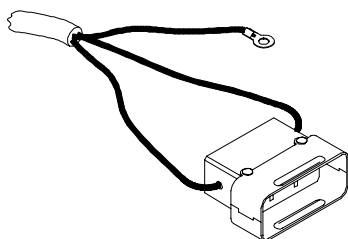

G0001	Wiring Set with 1 metre silicon tail	0.212
-------	--------------------------------------	-------

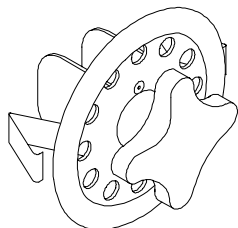

D0210	Black	Lamp Adjuster allows focusing of lamp from lantern exterior	0.146
D0211	Silver		0.146

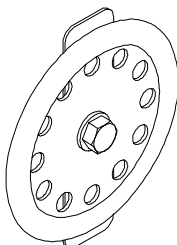

D6475	Cap Balking Plate To close off hole in lantern cap	0.096
-------	---	-------

RAYLITES:-

A Range of lightweight bright anodised aluminium reflectors designed to fit in place of par lamps to save weight. Lamp types available are, A1244 240V 500W, DYR 240V 650W, DYS 120V 600W.

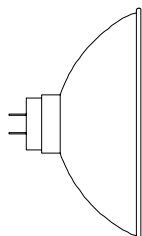

G1003	Raylite with Mogul Prongs - Narrow	0.144
G1004	Raylite with Mogul Prongs - Medium	0.144
G1005	Raylite with Mogul Prongs - Wide	0.144

Par 56 Raylite Reflector - Beam Angle		
Narrow	Medium	Wide
11°	21°	31°

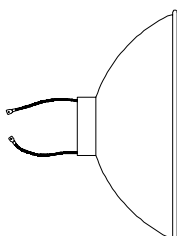

G1009	Raylite with short tails - Narrow	0.12
G1010	Raylite with short tails - Medium	0.12
G1008	Raylite with short tails - Wide	0.12